

Lincoln Star Residence IV

The Living That Inspires





THE LINCOLN GROUP

Dubai is a dynamic global city where rich traditions blend seamlessly with modern innovation. Discover iconic landmarks, wander through lively souks, unwind on beautiful beaches, and experience unparalleled luxury. With its diverse lifestyle, world-class facilities, and welcoming spirit, Dubai offers something special for everyone.





THE
FRENCH
COLLECTION



THE LINCOLN GROUP

The Living That Inspires

A photograph of a Parisian street at dusk. The street is lined with grand, multi-story buildings with many windows. Some windows are lit up, and the streetlights are on. There are cars parked along the side of the road and a few people walking on the sidewalk. The sky is a mix of blue and orange, suggesting sunset or sunrise. The overall atmosphere is elegant and sophisticated.

French Elegance. Modern Comfort.



Inspired by the timeless refinement of the **French Collection**, **Lincoln Star Residence IV** blends classical proportions with contemporary functionality.

Graceful forms. Harmonious layouts. Thoughtful detailing.

A residence that reflects sophistication with understated confidence.

Lincoln Star Residence IV is a sanctuary where architecture meets emotion, crafted for those who seek more than a home. Here, refined design and purposeful green spaces create an atmosphere that inspires movement, balance, and a deeply rooted sense of calm living.

Inspired by the elegance of the **French Collection**, every detail reflects timeless sophistication blended with modern comfort. It is a residence where families flourish, surrounded by beauty, harmony, and thoughtfully curated spaces that nurture connection.

At **Lincoln Star Residence IV**, life unfolds within serene landscapes and graceful interiors that elevate everyday living. More than a residence, it is a place to belong, grow, and experience comfort in its most meaningful form.



Palm
Jabal Ali

Palm Jumeirah

Burj
Al Arab

Burj
Khalifa

Dubai Marina

Dubai Frame

Deira

Emirates Hill

Sheikh Zayed Road

Sheikh Zayed Road

Al Barsha

Al Khail Road

Dubai
Creek

15 MINUTES

10 MINUTES

5 MINUTES

Lincoln Star Residence IV

Al Maktoum
International
Airport (DWC)

Central
Park

Cafeteria

Gas Station

Restaurant

Shopping
Mall

EMIRATES ROAD

EXPO CITY
DUBAI

Dubai AID
City

Dubai
Investment
Park

Jumeirah
Golf Estates

البرية العالمية
Global Village

LUXURY LIVING, PERFECTLY POSITIONED



Near
community park



Near
shopping & retail



Within the community
healthcare facilities



Within the community
educational institutions



10 minutes
Expo City



15 minutes
Al Makhtoum Int. Airport



15 mins to
Dubai parks & resorts



40 mins to
Burj Khalifa



30 mins to
Palm Jebel Ali



35 mins to
Burj Al Arab



30 mins to
Dubai Marina



35 mins to
Palm Jumeirah



Awaken to Inspired Living















A Community Designed Around Wellbeing

Expansive green spaces lie at the heart of the community, creating a tranquil environment where nature and everyday living coexist. Thoughtfully landscaped pathways encourage movement, while open courtyards foster moments of connection.

Here, mornings unfold with fresh air and natural light, and evenings settle into a quiet sense of calm. Wellness is not merely an amenity; it is the foundation of life here.

Elevated Living, Naturally

Spacious layouts are designed to welcome natural light, filling every home with warmth and vitality. Open-plan living areas blend comfort with effortless sophistication, creating spaces that are as inviting as they are functional.

Every detail has been carefully considered to enhance daily living, ensuring interiors that are bright, airy, and perfectly balanced between elegance and practicality.









Where Peace Meets Perfection

Each bedroom is crafted as a personal sanctuary, where balanced proportions, elegant finishes, and a serene atmosphere combine to create a haven of quiet comfort.

Spaces are thoughtfully designed to foster relaxation and rest, offering residents an environment that is both refined and deeply restorative.

Integrated smart-home features allow personalized control of lighting, temperature, and ambiance, ensuring an effortless and tailored living experience. Carefully designed storage solutions maintain a clean, uncluttered aesthetic, perfectly complementing the luxurious atmosphere.

Each bedroom is further enriched with bespoke touches and subtle architectural details, elevating everyday comfort into an immersive experience of refined sophistication.

AMENITIES



Swimming Pool



Kids Pool



Kids Play Area



Jacuzzi



BBQ Area



Sports Lounge



Open Activity Area



Multipurpose Area



Gym



Jogging Track



Meditation Zone

Wellness, Designed Into Everyday Living

A contemporary fitness center thoughtfully crafted to support strength, endurance, and balance. Bathed in natural light and defined by a refined layout, the space provides an inspiring environment for maintaining an active lifestyle.

Just moments from home, residents can embrace a routine that prioritizes wellbeing, making wellness a natural and effortless part of everyday life.

The fitness center is complemented by wellness amenities such as meditation areas, recovery zones, and hydration stations, creating a holistic environment that nurtures both body and mind.

Regular wellness programs and expert-led classes further encourage residents to engage actively, fostering a vibrant and health-focused community.







Designed for Meaningful Family Moments

A dedicated children's play area thoughtfully created to inspire imagination, encourage movement, and ensure safe exploration.

Because a truly exceptional residence is one that nurtures the wellbeing of every generation.

Interactive zones, creative installations, and age-appropriate equipment encourage learning, social interaction, and physical activity in a fun and engaging setting.

Supervised spaces and strategically designed layouts give parents peace of mind while children explore freely, allowing families to enjoy a harmonious balance of safety and adventure.

A Residence of Enduring Value



A Place to Belong

Imagine mornings wrapped in greenery.
Afternoons filled with light and laughter.
Evenings grounded in quiet elegance.

This is where balance is found.

This is where life feels complete.



Floor Plans

Ground Floor



1st & 4th Floor

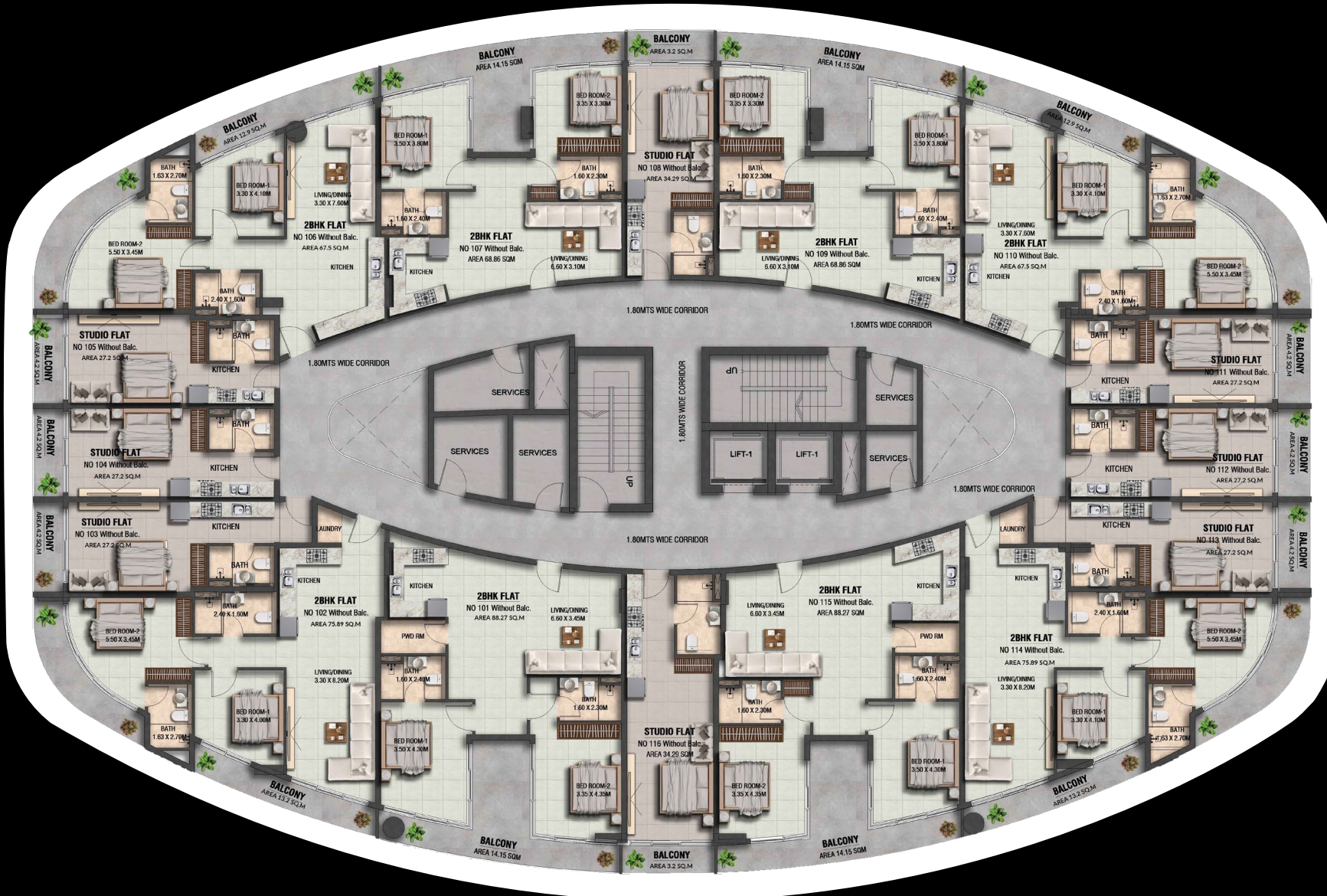

2nd & 3rd Floor



Rooftop

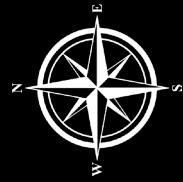

Unit Plans

TYPICAL FLOOR

Studio

1st & 4th Floor

TYPE: A

SIZE: 337.95 sq. ft.

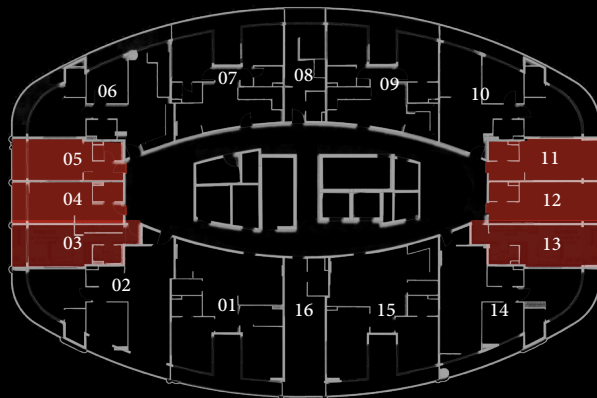

UNIT NO. 03 - 04 - 05 - 11 - 12 - 13

TYPICAL FLOOR

Studio

1st, 2nd, 3rd & 4th Floor

TYPE: B

SIZE: 403.50 sq. ft.

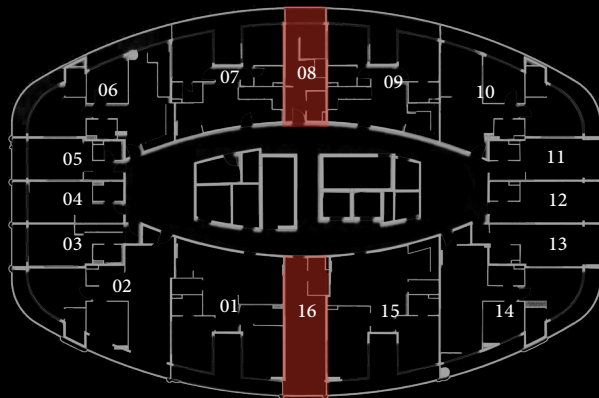

UNIT NO. 08 - 16



TYPICAL FLOOR

Studio

2nd & 3rd Floor

TYPE: C

SIZE: 427.614 sq. ft.

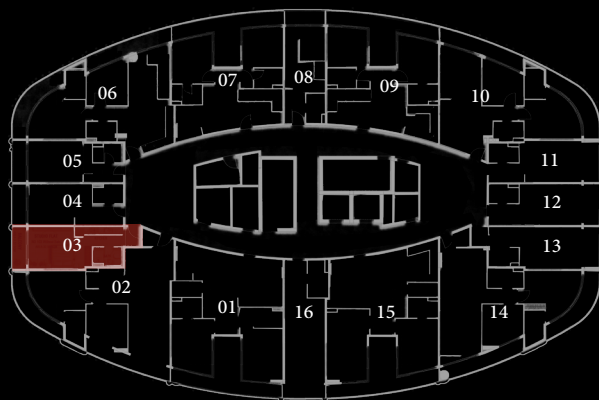

UNIT NO. 03

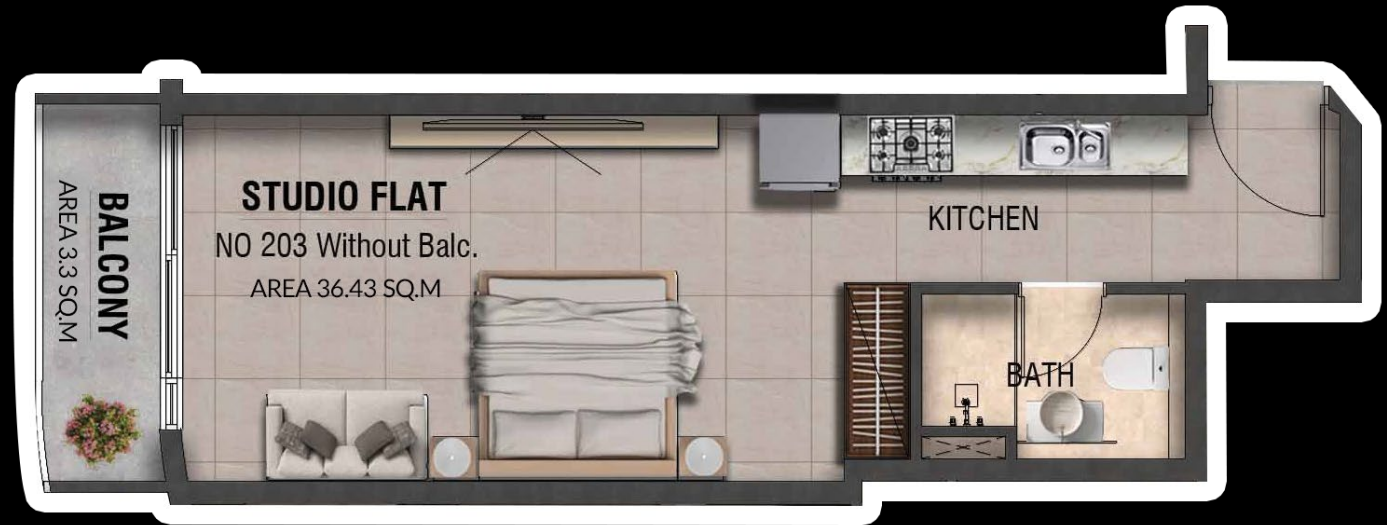

TYPICAL FLOOR

Studio

2nd & 3rd Floor

TYPE: D

SIZE: 431.38 sq. ft.

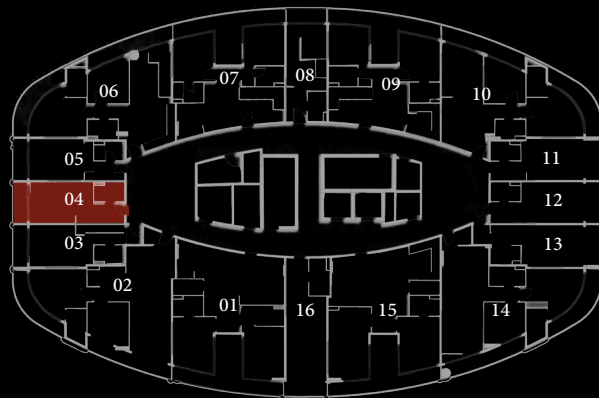

UNIT NO. 04

TYPICAL FLOOR

Studio

2nd & 3rd Floor

TYPE: E

SIZE: 423.63 sq. ft.

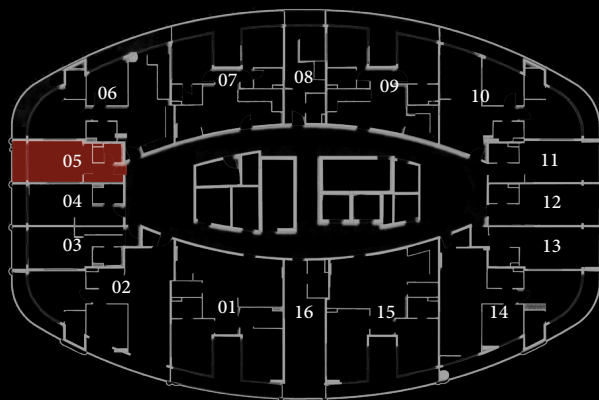
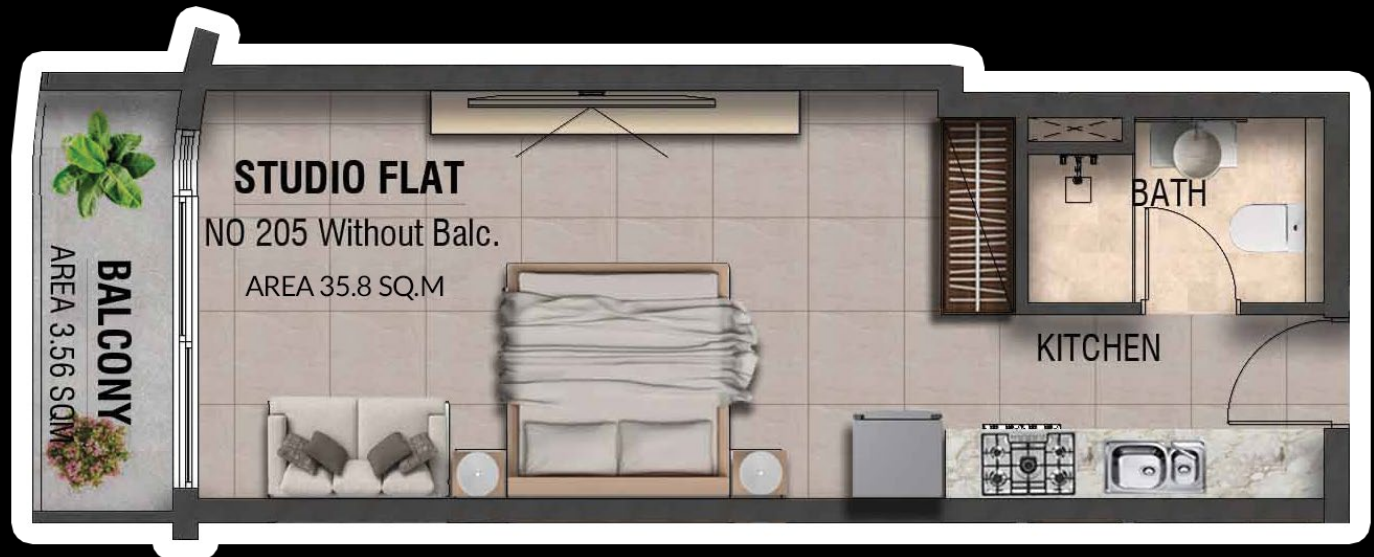

UNIT NO. 05

TYPICAL FLOOR

Studio

2nd & 3rd Floor

TYPE: F

SIZE: 413.83 sq. ft.

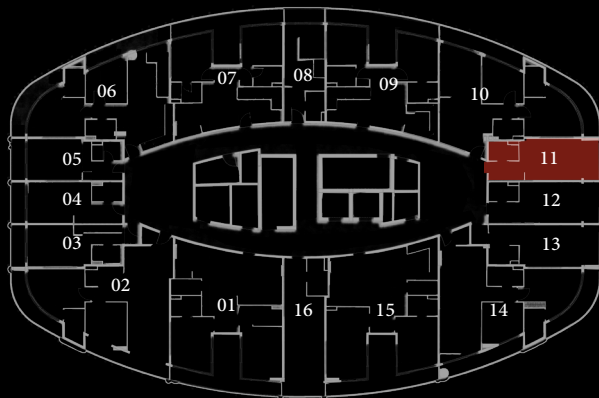

UNIT NO. 11

TYPICAL FLOOR

Studio

2nd & 3rd Floor

TYPE: G

SIZE: 431.70 sq. ft.

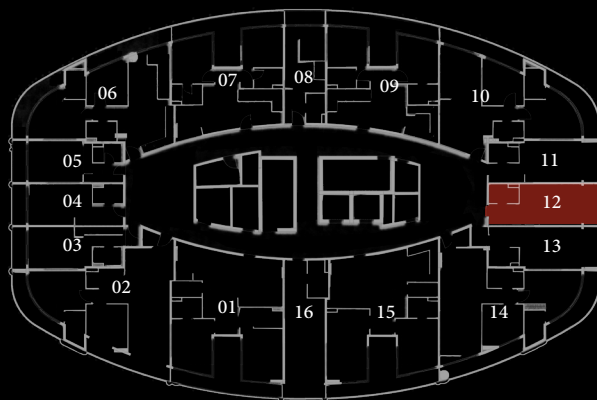

UNIT NO. 12

TYPICAL FLOOR

Studio

2nd & 3rd Floor

TYPE: H

SIZE: 419.97 sq. ft.

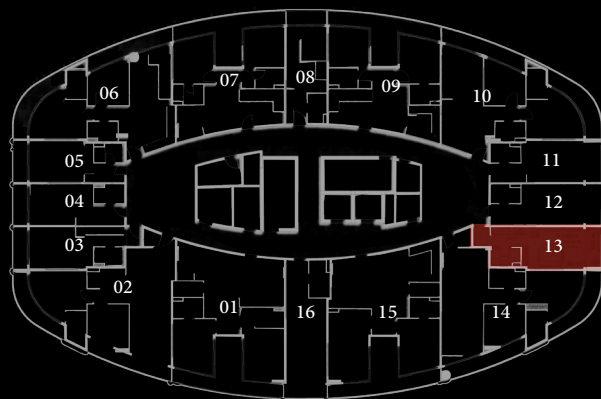

UNIT NO. 13



ROOFTOP

Studio

TYPE: I

SIZE: 401.45 sq. ft.

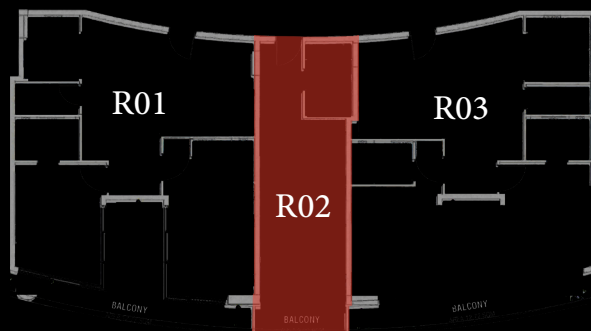

UNIT NO. R02

GROUND FLOOR

1BHK

TYPE: A

SIZE: 774.82 sq. ft.

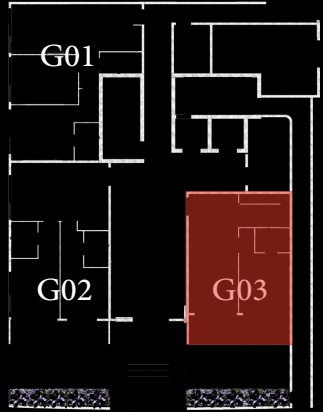

UNIT NO. G03



GROUND FLOOR

2BHK

TYPE: A

SIZE: 879.22 sq. ft.

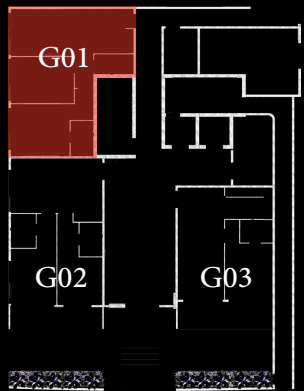

UNIT NO. G01

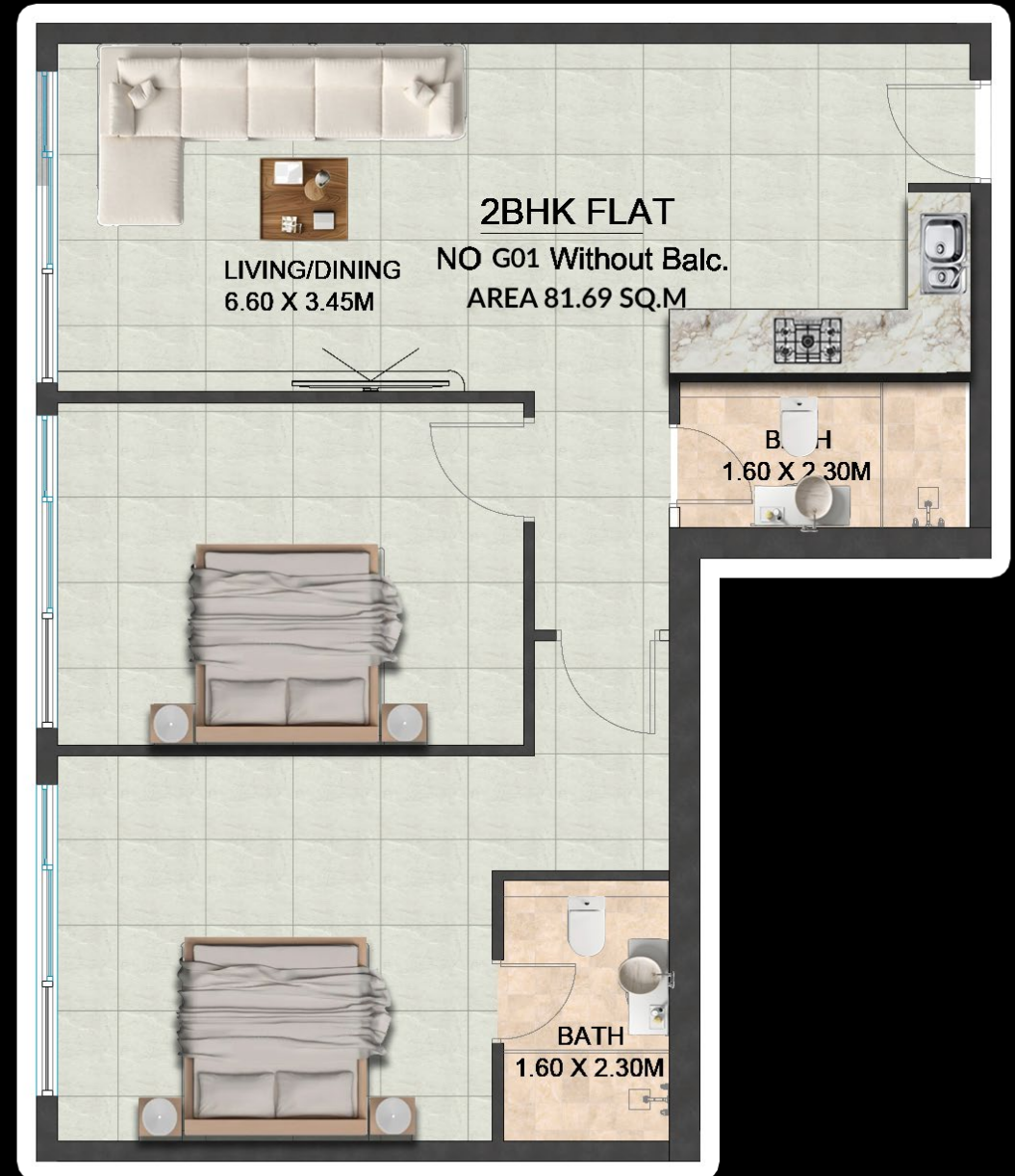

GROUND FLOOR

2BHK

TYPE: B

SIZE: 908.93 sq. ft.

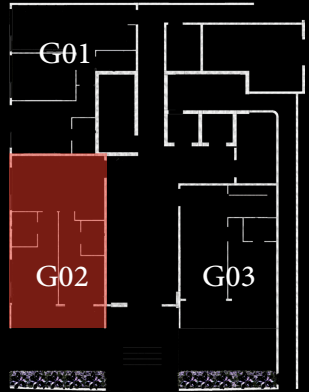

UNIT NO. G02



TYPICAL FLOOR

2BHK

1st & 4th Floor

TYPE: C

SIZE: 865.34 sq. ft.

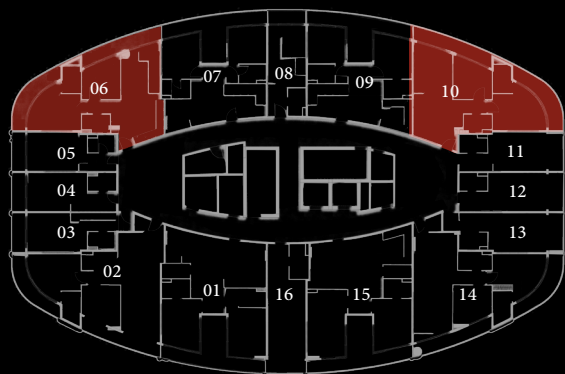

UNIT NO. 06 - 10

TYPICAL FLOOR

2BHK

1st, 2nd, 3rd & 4th Floor

TYPE: D

SIZE: 893.43 sq. ft.

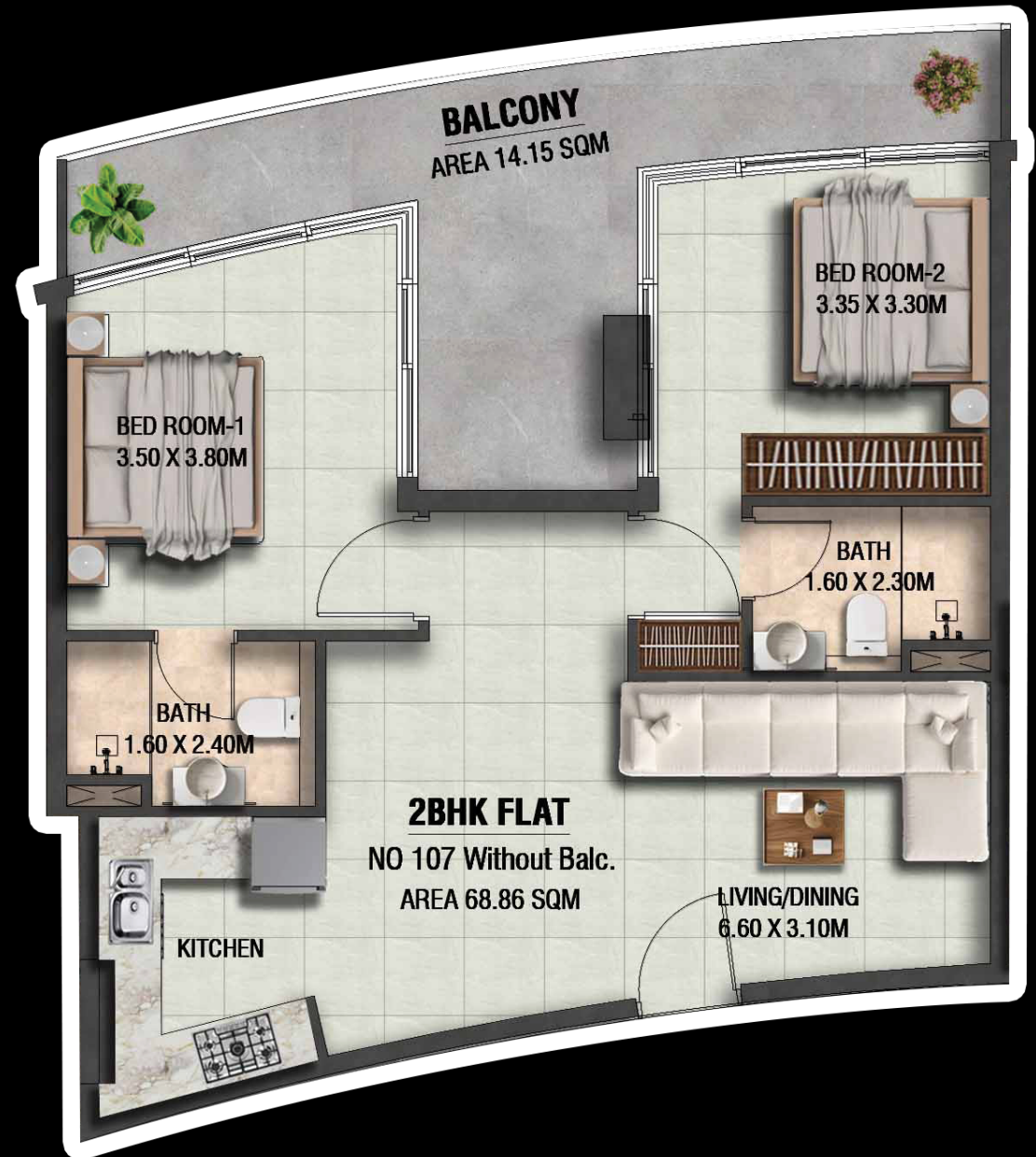
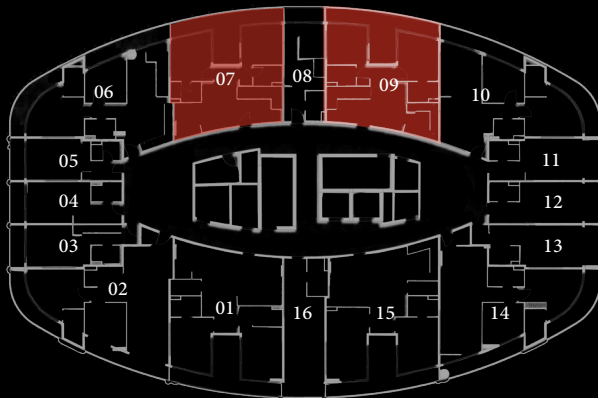

UNIT NO. 07 - 09

TYPICAL FLOOR
2BHK

2nd & 3rd Floor

TYPE: E

SIZE: 912.91 sq. ft.

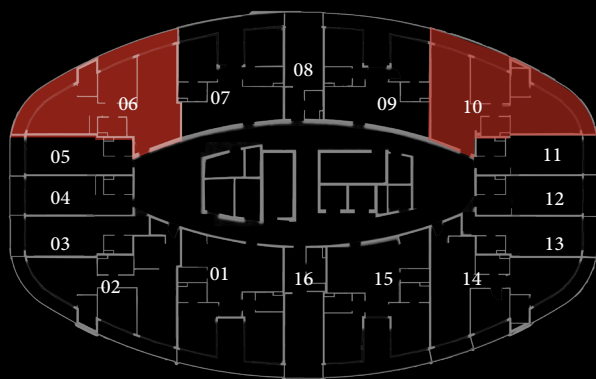

UNIT NO. 06 - 10

TYPICAL FLOOR

2BHK

1st, 2nd, 3rd & 4th Floor

TYPE: F

SIZE: 1102.34 sq. ft.

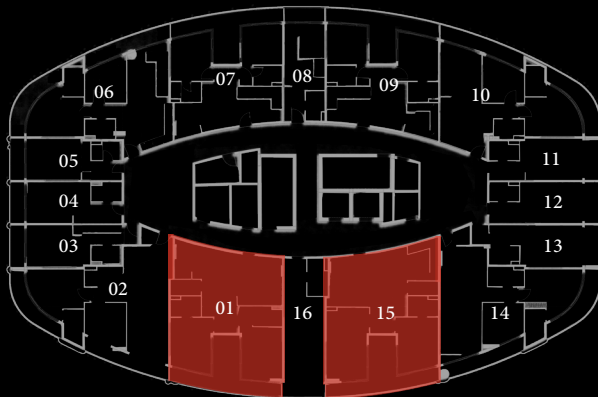

UNIT NO. 01 - 15

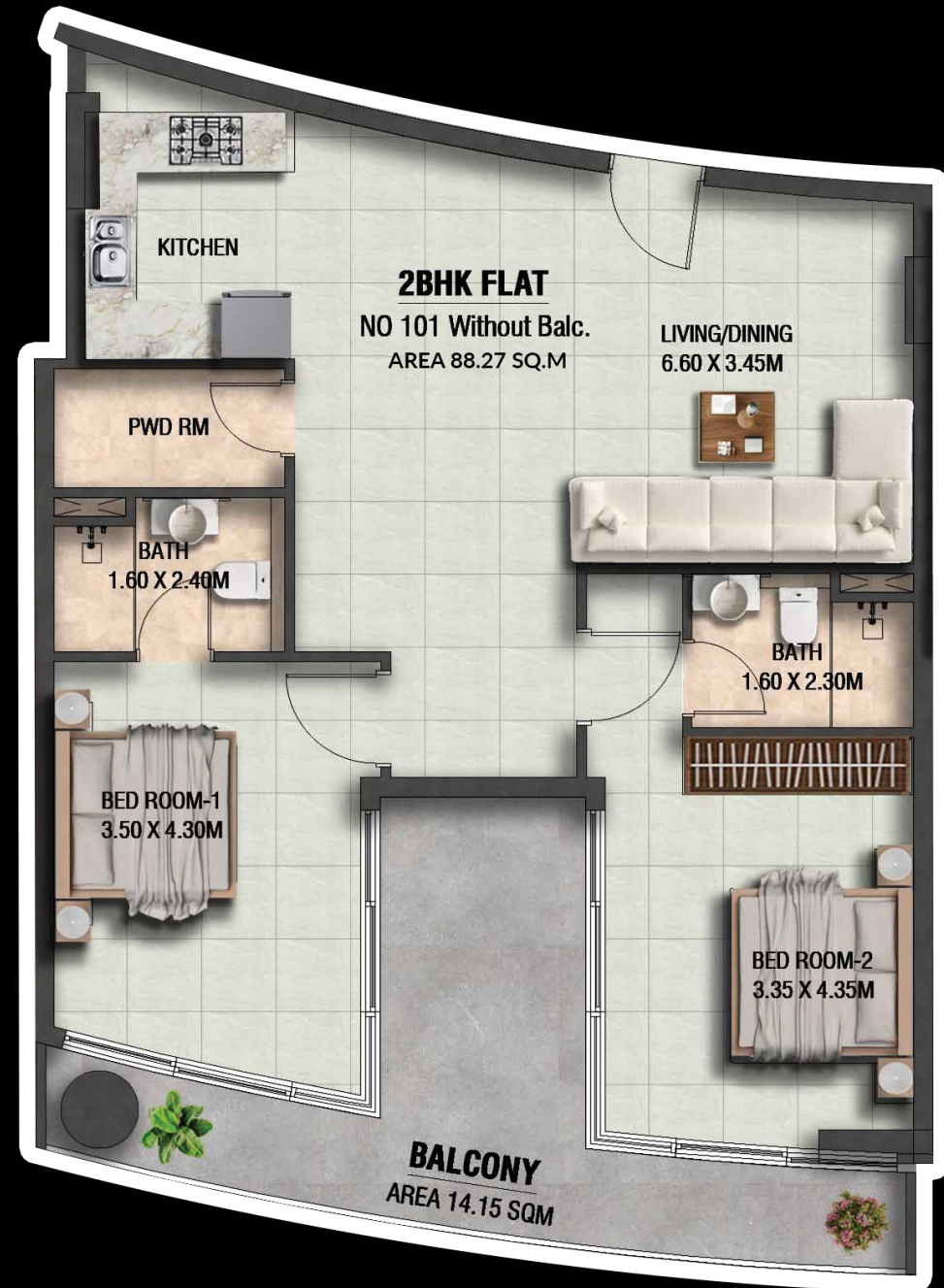

TYPICAL FLOOR

2BHK

1st & 4th Floor

TYPE: G

SIZE: 958.87 sq. ft.

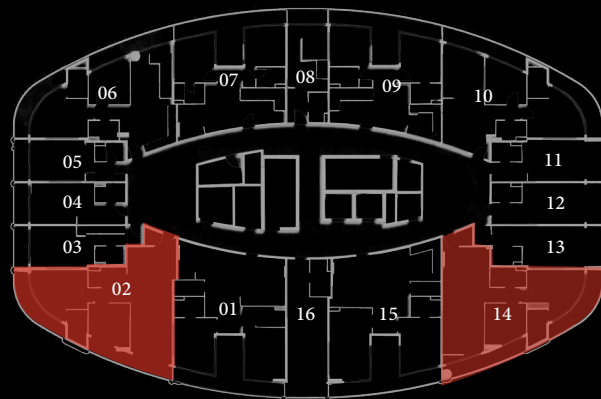

UNIT NO. 02 - 14

TYPICAL FLOOR
2BHK

2nd & 3rd Floor

TYPE: H

SIZE: 1005.47 sq. ft.

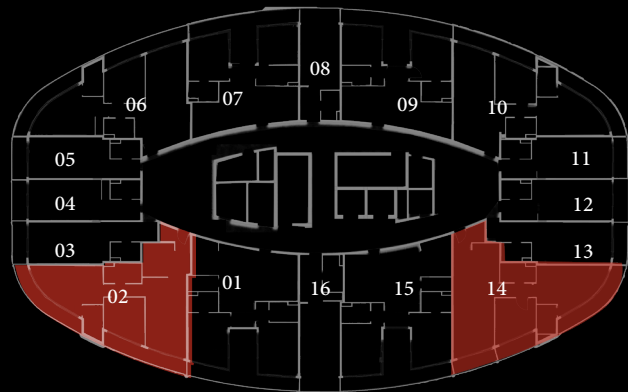

UNIT NO. 02 - 14

ROOFTOP

2BHK

TYPE: I

SIZE: 1086.95 sq. ft.

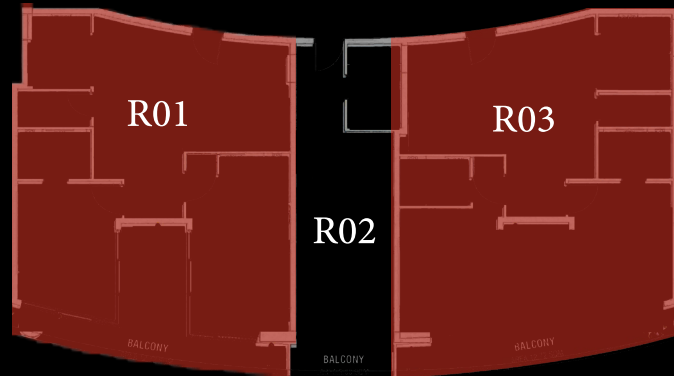

UNIT NO. R01 - R03





The Lincoln Group

The Living That Inspires

www.thelincolngroups.com
info@thelincolngroups.com | +971 4 554 7133



**McCardell
Construction**

STRATEGIC PARTNER